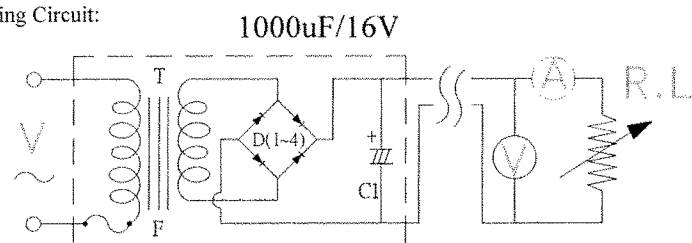
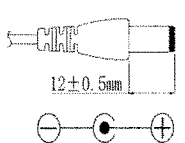
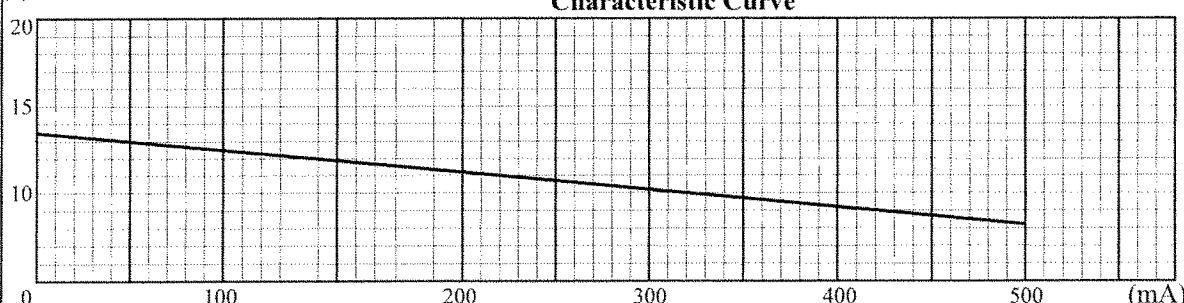

### TEST DATA

ITEM	SPEC	SAMPLE									
		1	2	3	4	5	6	7	8	9	10
Primary Exciting Current Input 120VAC , 60 Hz	60 mA max	36	36	37							
Primary Load Current Input 120VAC , 60 Hz	95 mA max	80	80	80							
Secondary No Load DC Voltage	13.5V ±5%	13.37	13.3	13.7							
Secondary DC Voltage Load 500 mA	9V ±5%	9.1	9.09	9.12							
Secondary Voltage Load mA	V ± %										
Secondary Voltage Load mA	V ± %										
Secondary Voltage Load mA	V ± %										
Secondary Voltage Load mA	V ± %										
Ripple Voltage Load 500 mA (PK-PK)	2.5V max	1.8	1.8	1.8							
Hi-Pot Test 3 mA for 3Sec.	Pri. to Sec.	2K VAC	OK	OK	OK						
	Pri. to Core	2K VAC	OK	OK	OK						
	Sec. to Core	1.5K VAC	OK	OK	OK						
Temperature Rise: 70°C MAX measured By Resistance Method (Primary Winding)											
Core Film: SPLIT						Core : EI-35					
Testing Circuit:		1000uF/16V				Output Plug Drawing: PLUG:5.5X2.1mm					
											
Output conductor length:		6 ft		min ( AWG#22 )							
Input conductor length:		ft min		(AWG# )							
(V) <b>Characteristic Curve</b>											
											

## DC Adaptor Specifications

---

### Internal Construction Drawing and Parts List (Unit: Set or EA)

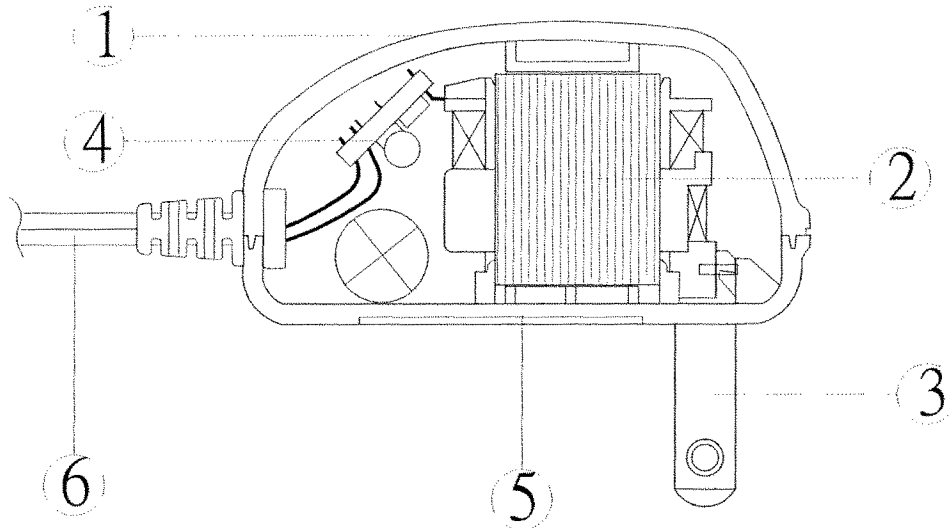

Part Name	Specification	Q'ty
1. Enclosure	Noryl SE1 94V-1 105°C	
	Noryl SE-100 94V-1 85°C	
	Noryl PX1700 94V-1 80°C	
	940(f1) 94V-0 130°C	
2. Transformer	EI-35	1
3. Blade	Ni plated brass	2
<b>4. Print Wiring Board Assembly</b>		
Print Wiring Board	04V0 94V-0 130°C	1
	11 94V-0 105°C	
	13 94V-0 130°C	
	BF-3 94V-0 130°C	
Diode	1A 400V IN4004	4
Capacitor	1000uf 16V 85°C	1
5. Name Plate	Polyester Film	1
6. Output Cord	AWG#22 6FT min	1



## DC Adaptor Specifications

### Construction Drawing and Details of Transformer

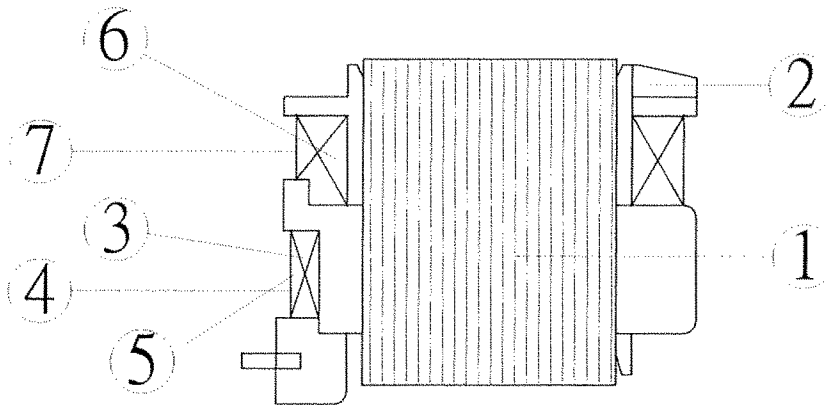

Part Name	Material & Type	Spec or Q'ty
1. Core	Silicon Steel	0.5mm
2. Bobbin	Polybutylene Terephthalate	0.71mm
	1403G6	
	PETP(QMFZ2)	
	FR-530, FR530L	
3. Primary Winding	Polyurethane Enameled	mm turn ohm
	Copper wire	
4. Primary Outer Winding	Mylar Tape	0.025mmx2T
5. Thermal Fuse)	M30 2A 125°C 250V AC	1PC
6. Secondary Winding	Polyurethane Enameled	mm turn ohm
	Copper Wire	
7. Secondary Outer Winding	Mylar Tape	0.025mmx2T

## DC Adaptor Specifications

---

### Circuit Diagram

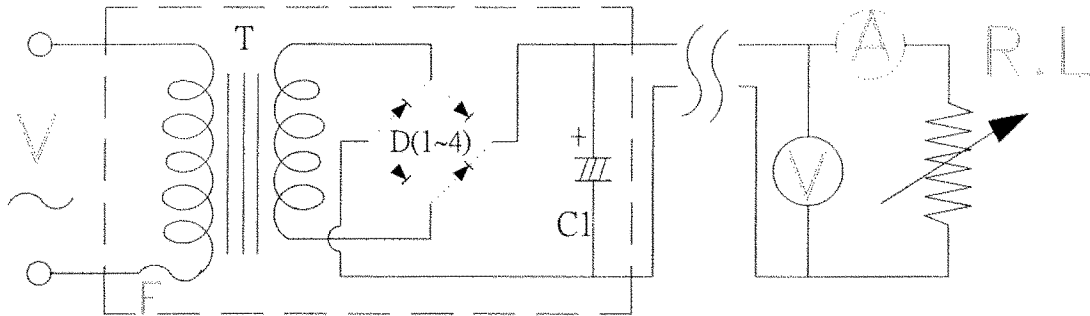

Symbol	Part Name	Note
T	Transformer	EI-35
D(1-4)	Diode	1A 400V IN4004
C	Capacitor	1000uF 16V 85°C
F	Thermal	125°C 2A 250V

---

## DC Adaptor Specifications

---

### Appearance Drawing (Unit:mm)

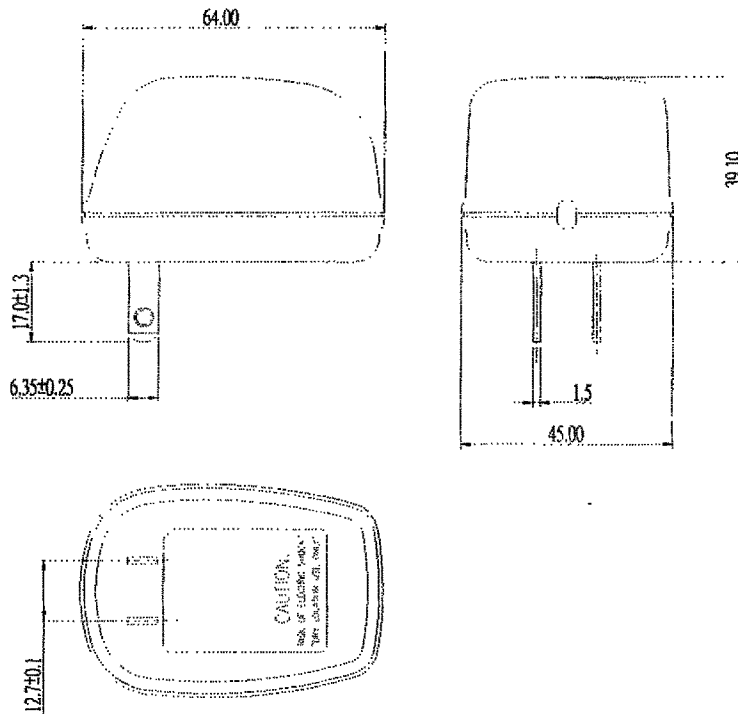

## DC Adaptor Specifications

### Dimension of Nameplate (Unit:mm)

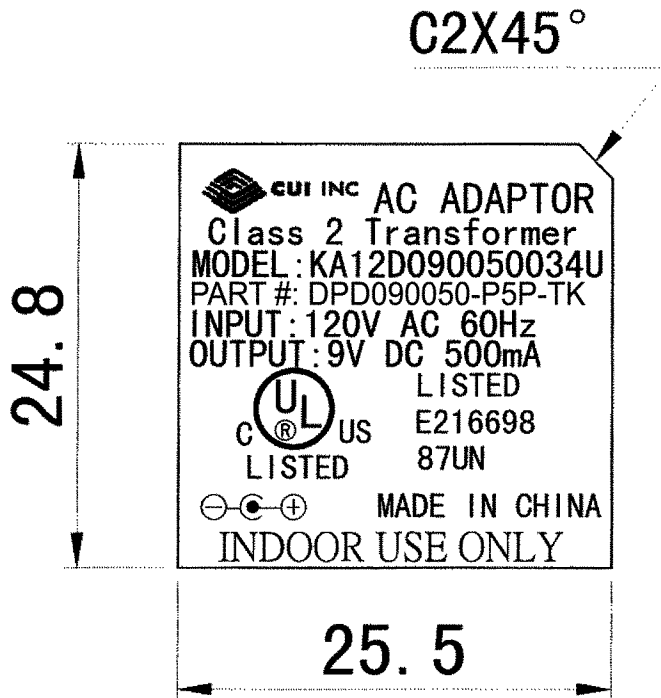

Material: Polyester Film

T: 0.25mm